

# Impairment of the Endothelium and Disorder of Microcirculation in Humans and Animals Exposed to Infrasound due to Irregular Mechano-Transduction

Ursula Maria Bellut-Staeck

Independent Scientist, Berlin, Germany

Email: drmed.u.bellut@t-online.de

**How to cite this paper:** Bellut-Staeck, U.M. (2023) Impairment of the Endothelium and Disorder of Microcirculation in Humans and Animals Exposed to Infrasound due to Irregular Mechano-Transduction. *Journal of Biosciences and Medicines*, 11, 30-56.

<https://doi.org/10.4236/jbm.2023.116003>

**Received:** April 24, 2023

**Accepted:** June 10, 2023

**Published:** June 13, 2023

Copyright © 2023 by author(s) and Scientific Research Publishing Inc.

This work is licensed under the Creative Commons Attribution International License (CC BY 4.0).

<http://creativecommons.org/licenses/by/4.0/>



Open Access

## Abstract

The microcirculation of mammals is an autoregulated and complex synchronised system according to the current demand for nutrients and oxygen. The undisturbed course of vital functions such as of growth, blood pressure regulation, inflammatory sequence and embryogenesis is bound to endothelial integrity. The sensible vasomotion is particularly dependent on it. Mechano-transduction signalling networks play a critical role in vital cellular processes and are the decisive physiological mechanism for an adequate NO-release, main responsible for the autoregulation of vessels. Disturbed endothelial integrity, originating, e.g., from chronic oxidative stress and/or mechanic (oscillatory) stress, leads to disturbance of vasomotion as well as a disequilibrium of redox systems, recognized as main cause for the development of chronic inflammation diseases such as atherosclerosis and corresponding secondary illnesses, possibly cancer. The endothelial cytoskeleton, which corresponds to a viscoelastic “tensegrity model”, offers the possibility for mechano-transduction via its special construction. The rapidly growing knowledge about mechanical forces in cellular sensing and regulation of the last years (that culminated in the Nobel Prize award for the decoding of pressure/vibration sensing ion channels), led us to the following hypothesis: The extern stressor “Noise” produces under certain conditions an oscillatory stress field in the physiologically laminar flow bed of capillaries, which is able to lead to irregular mechano-transductions. Findings provide a strict dependence on frequency in mechano-transduction with determination of thresholds for a 1:1 transmission. The knowledge, recently gained on endothelial mechano-transduction, sheds a new light on the importance of low frequencies. This could indicate the long-sought pathophysiological way in which infrasound can exert a stressor effect at the cellular level. Noise-exposed citizens, who live near infra-

---

structures such as a biogas installation, heat pumps, block-type thermal power stations and bigger industrial wind turbines (IWT's), show worldwide mainly a symptomatology associated with microcirculatory disorder. Conceivable are also effects on insects or fishes, since the piezo-channels are recognised as conserved structures of all multicellular organism. An experimental design is proposed to demonstrate the direct pathological influence of infrasound of defined strength, frequency, effect/time profile and duration on the sensitive vasomotion.

## Keywords

Mechano-Transduction, Endothelial Cytoskeleton, Infrasound, Oscillatory Stress, Vasomotion

---

## 1. Introduction

### 1.1. Structure, Components and Regulation of the Microcirculation System in Mammals

The flat endothelial cells line all the mammal's vessels (including lymph vessels) as its largest organ. Responsible for the entire transport of energy- and substrate metabolism as well as for many vital functions, they have a very large surface area (approx. six football fields in adults) [1]. The endothelial cell corresponds in its structure to a somatic cell and is specified for its diverse tasks, whereby the respective vessel (capillary vessel, artery) as well as the type of tissue (splanchnic area, kidney, brain) is responsible for its further specification [2]. It differs in shape, expression and surface as well as its staffing of receptors of the adrenergic system. According to their ultrastructure, endothelial cells are differentiated, depending on their organ-specific substructure, into various types of continuously, fenestrated and discontinuous endothelium. The circulatory system is self-contained in a combination of vessels, connected in series and in parallel, in which, in accordance with Ohm's law, the total resistance decreases with each additional parallel connection [2]. By regulating the resistance via the upstream arterioles, we physiologically find laminar flows with uniform velocity, strictly bound to the vessel size, in the capillary network. This is a crucial precondition for the diverse and vital tasks of the microcirculation [2] [3]. In contrast, we find chronic oscillatory stress, a strong causal factor for atherosclerosis, at vascular branches and stronger curves of medium and larger vessels. One of the main tasks of microcirculation is to adapt vascular blood flow to current needs [1] [4]. The functional vessel density (FVD) in resting muscle is about 25% of the total vessel density (TVD). Conversely, this also means that blood flow can be increased by a multiple [5]. The compensatory capacity of the capillary network is thus many times higher than that of the "macrocirculation". Under physical strain, a so-called *capillary recruitment* according Moore and Fraser 2015 [6], begins by lowering the vascular resistance of upstream arterioles, resulting in a significant increase in the nutrient exchange surface and a decrease in the distance between

two capillaries with a consequently reduced diffusion distance for oxygen and nutrients. The regulation of local blood flow (so-called vasomotor function) is extremely complex and “orchestrated” [4]. It is controlled by intrinsic and extrinsic factors (e.g., autonomic nerve system and vasoactive hormones, e.g., *adrenaline*, *vasopressin*, *angiotensin*, *serotonin*) which modulate intrinsic activity [1], dependent also on vessel size and the distribution of adrenergic receptors to a given organ.

One basis for *intrinsic* regulation is formed by the Bayliss effect [7]. Blood flow is kept constant: If blood flow increases, vasoconstriction occurs, if blood flow falls, vasodilation occurs. A second basis is metabolite factors according to the classical theory, in which local hypoxia leads to an increased release of vasodilatory active substances (e.g., *NO*, *ATP*, *prostaglandins*), causing an increase in local blood flow. Accumulating metabolites such as *lactate*, *hydrogen ions*, *potassium* and *adenosine* maintain this effect [1]. One of the most important and mainly responsible prerequisites for the *NO bioavailability* is the classical laminar shear stress response due to mechanical forces according Chien 2007 [8]. *NO* is triggered in the classical way by blood flow causing a mechanical change at the endothelial cell membrane and formed from its precursor L-arginine via *NO-synthetase (NOS)*. *NO* mediates vascular relaxation by activation of the soluble guanylyl cyclase (sGC) which catalyses the conversion of guanosine triphosphate (GTP) into 3'-5'-cyclic guanosine monophosphate (cGMP).

The latter is extraordinarily typical for the microcirculation, but one of the least explained phenomena: *vasomotion*.

Vasomotion was first observed in the classical example of a bat vein and described as a rhythmic contractility that accelerates blood flow forward via fine and synchronised pulsations [9]. The causes and control of which have not yet been fully elucidated. Current state of knowledge is that *vasomotion* depends on the integrity of the endothelium and apparently serve to optimise the nutrient support [10]. *Vasomotion* can be directly observed *in vivo* in SDF-video microscopy. Quote from Aalkjaer C. Mulvany MJ 2020) [10] in cap. 1.3 page 7: “*Perhaps the only feature related to vasomotion which is agreed by everybody is that an oscillation of the smooth muscle cell membrane potential is the background for the oscillation of the individual smooth muscle cell tone and also for the synchronization of the smooth muscle cells [...] This strongly suggests that [Ca<sup>2+</sup>] in the smooth muscle cells is also oscillating in a synchronized manner—and this is indeed the case. [...]*”. There is deeper insight in the original article [10].

The extent of endothelial involvement in clinical syndromes is immense, as are the potential factors that can influence microcirculation in both positive and negative ways. The most important potential influences arise from vital functions such as oxygen and nutrition supply, growth, embryogenesis, blood coagulation, immune regulation, etc. The main causes of dysfunction are those that can disrupt the integrity of the endothelium, in particular an excess of oxidative and oscillatory stress.

## 1.2. Redox System Homeostasis

Crucial for both, a synchronised blood flow regulation and the maintenance of vascular health, is the adequate release of *NO* with the right amount, right quantity, at the right place and to the right time [11]. *As strong antioxidant, it plays a decisive role in the homeostasis of the entire redox metabolism with interruption of lipid peroxidation and therefore decrease of aggressive free oxygen radicals (ROS) ([11] [12] Table 1)*. As free radical (in a gaseous state), it can diffuse freely through the membranes. The vascular effects of *NO* are presented *as vascular protective, regulatory or as deleterious* [11] [13]. How the reaction really turns out, depends according to Laurindo F. *et al.* [11] on several factors. According to these authors, the unfavourable properties usually are associated with an *excessive* *NO* production, the *protective NO effects* are attributed to a steady and *for the specific situation adequate NO production*. Not only *NO*, but also its three isoenzymes of endothelial *NO*-Synthetase are involved in redox signalling pathways. Depending the kind of isoenzyme and surrounding conditions, they have likewise either protective effects or such that are deleterious as shown in **Table 1**.

*As a result*, the dependence of an adequate *NO*-provision on physical forces leads to a sensitivity to external stressors that would be capable of leading to irregular mechano-transduction, possibly leading to an increased and inadequate *NO* supply. More details to the whole theme in articles from [11] [12] [13] [14].

**Table 1.** The different possible effects of Nitric Oxide as protective, regulatory and deleterious.

<i>Protective effects:</i>
<ul style="list-style-type: none"> <li>• Antioxidant</li> <li>• Inhibits leucocytes and platelets adhesion</li> <li>• Protects against toxicity and peroxidation</li> </ul>
<i>Regulatory effects:</i>
<ul style="list-style-type: none"> <li>• Vascular tone</li> <li>• Cell adhesion</li> <li>• Vascular permeability</li> <li>• Neurotransmission</li> <li>• Bronchodilation</li> <li>• Inflammation regulation</li> <li>• Regulation renal function</li> </ul>
<i>Deleterious effects</i>
<ul style="list-style-type: none"> <li>• Inhibits enzymatic function</li> <li>• Induces DNA damage</li> <li>• Induces lipid peroxidation</li> <li>• Increases susceptibility for radiation, alkylating substances, toxic metals</li> <li>• Depletes reservations of antioxidants</li> </ul>

After Original source [13] FIG 1 in WINK AA. MITCHELL J (1998) CHEMICAL BIOLOGY OF NITRIC OXIDE: INSIGHTS INTO REGULATORY, CYTOTOXIC, AND CYTOPROTECTIVE MECHANISMS OF NITRIC OXIDE, Radiation Biology Branch, National Cancer Institute, Bethesda, MD, USA from Book Free Radical Biology & Medicine, Vol. 25, Nos. 4/5, pp. 434-456, 1998. Published by Elsevier Science Inc. 0891-5849/98 \$0.00 1.00 reference FIG 1 Page 435.

In the area of the microcirculation, further vasodilating substances play a decisive role. Vascular segments in arterioles respond to endothelial autacoids such as angiotensin, serotonin, eicosanoids [2] and to agonists such as acetylcholine, bradykinin, or substance P as well as to transmural pressure changes. They do this not as isolated entities, but in a *coordinated manner*. This is attributed to the *Endothelium-derived-hyperpolarising-factor (EDHF)* [11]. *EDHF* has a long-distance effect, as its locally triggered formation can also trigger a rectified vascular response up- and downstream. The calcium-dependent activation of potassium efflux by *EDHF* is followed by hyperpolarisation with transmission of electron transfer within the vessel wall via the *gap junctions* and without loss of time [15]. The transmission reaction is comparable to a *school of fish*, very fast and synchronised [5]. The possibilities of microtactile stimulation compared to triggering via acetylcholine, were experimentally tested and confirmed [5].

### 1.3. Inflammation and Fibrosis Homeostasis

All sequential series of reactions here depend on the *integrity* of the endothelium and involve the endothelial cytoskeleton. Since it is a *vital endothelial function*, the complex process of inflammation can be disrupted at any level according to Suthahar [16]. In line with its high relevance to the topic of our work, we present a more detailed description to show how sensible the whole process, e.g., *for mechanic stress*, is: An inflammatory response is essential as a physiological defence mechanism against, e.g., bacteria, viruses, injuries. Point of no return is the diapedesis of leucocytes. The further course leads in the favourable case to a *restitutio ad integrum*, in the unfavourable to a *chronic inflammation* with fibrosis, defect healing and possible organ damage.

Important works on the state of the science come from Ley *et al.* (2007) [17] and Serhan *et al.* (2007) [18], related work in particular from Nussbaum and Sperando (2011) [19] and [1] [20]. According to Ley [17], the orderly process in all phases is crucial for its outcome. Here is presented the undisturbed course:

The circulating leukocytes move passively in the blood stream. In the postcapillary venules, local changes near sites of inflammation in the hemodynamics lead to a reduced blood flow rate. This increases the likelihood of leukocytes coming into contact with endothelia. The endothelium is in an activated state for a few hours and expresses adhesion molecules that lead to leukocyte binding. The “*slow rolling*” of leukocytes is also made possible by another inducible endothelial *E-Selectin*, which is based on a partial activation of *Integrins* on the leukocytes [17] (compare **Figure 1**). The actin cytoskeleton is as well actively involved in this process. Further chemokines, partly from the endothelium and partly from the extracellular space (ECR), activate tight binding and then amoeboid passage of leukocytes into the ECR. Selective changes in permeability (gatekeeper-function of the endothelial cell) allow cellular components such as neutrophils and monocytes, to move from the intravascular space to the ECR. More details to the sequences in *leucocytes diapedesis* are presented in standard works [1] [19]. There is an intensive interplay between endothelial secreted mediators

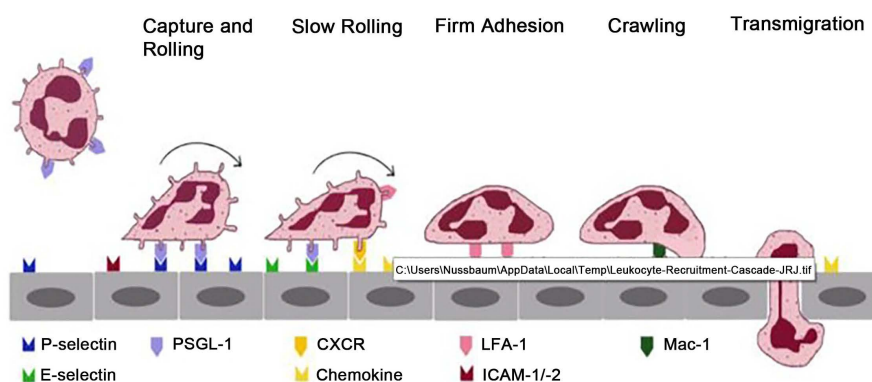

**Figure 1.** Original description: Schematic overview of the leukocyte recruitment cascade using the example of a neutrophil leaving a postcapillary venule. Capture and rolling are mediated by interaction of selectins with PSGL-1 on the neutrophil surface. During rolling, the neutrophil is activated by chemokines presented on inflamed endothelium leading to firm adhesion through binding of neutrophil integrins (LFA-1 and Mac-1) to endothelial adhesion molecules (e.g., ICAM-1 and -2). Upon firm adhesion, the neutrophil spreads and begins to crawl along the endothelial lining in search of an appropriate site for transmigration. States of leucocytes diapedesis: Capture and rolling, Slow rolling, Firm adhesion, Crawling, Transmigration Original source [19] Nussbaum, C., Sperando, M. (2011): Innate immune cell recruitment in the foetus and neonate. J Reproduction. Immunol 2011; 90(1): 74-81. (IF 2, 966). Page 2 FIG 1 With permission.

(*cytokines*) and such of the ECR [1] [16]. Anti-inflammatory signals such as *corticosterone* mitigate the severity and limit the duration of the early phase [16].

In summary, the process of inflammation is a complex interplay between a temporally and spatially defined process of mutual influence and activation between factors of the intra- and extra-vascular space. At the centre of the process is the adequate *gate-keeper-function* of an endothelium in an integrity state. After diapedesis of the leucocytes, an orderly process depends on the absence of increased oscillatory and oxidative stress, in order to lead *to a restitutio ad integrum*. In the other case, defect healing can occur due to a shift of the equilibrium in the direction to chronic inflammation and fibrosis. In the clinical medicine shifts to a chronic inflammation and the prevention of themselves play a big role [15].

The standard works by Buckley *et al.* (2014) [21] and Serhan *et al.* (2007) [18] describe the sequences after the leukocyte diapedesis: Appropriate “*checkpoints*” and “*stop signals*” prevent further leukocyte entry. *Lipoxins*, *resolvins* and *prostaglandins* act in an active pro-resolving process. This paves the way for the migration and differentiation of monocytes to phagocytosis, for the chemokine gradient normalisation (which allows the leukocytes to undergo apoptosis) and for exiting the tissue via the draining lymphatic vessels. Failure of such regulatory mechanisms can lead to a state of *chronic inflammation*, causing continuous tissue damage and progressive fibrosis. A classic example is the chronic heart failure by “remodelling” of heart [16].

At heart, immunocompetent myofibroblasts and factors of the ECR actively

modulate the development of initially perivascular and later progressive fibrosis. Starting points can be the development of myocarditis into a chronic form, state after myocardial infarction and/or *chronic mechanic pressure load on the heart* (systemic high pressure or pulmonary hypertension). The consequence is the increase in diffusion distance, the decrease in capillary density, an impaired electroconductive system with cardiac arrhythmia, disruption of angiogenesis, leading again to a deteriorated substrate and oxygen supply with a self-reinforcing process: *a vicious circle* [16].

#### 1.4. Hemodynamic Forces

Physiologically physical forces constantly act on the organism, e.g., gravity, pressure, shear stress, vibration. The major ones are tangential forces (e.g., laminar shear stress) or stretching forces (e.g., pulsatile distention) from the blood according to Fernandes, C.D. *et al.* (2018) [3] and Mazzag *et al.* (2014) [22]. As described above, internal oscillatory stressors are physiologically limited by the vessel size which is a critical factor in maintaining vital functions [3]. The regulation of several vital cellular processes via mechano-transduction and signalling networks including growth, differentiation, migration, angiogenesis and apoptosis, is essential [1] [3]. During morphogenesis shear stress directs the formation of the vascular tree according Hahn and Schwartz (2009) [23]. Changes in shear stress determine instantaneous vasomotor changes which are regulated on a “beat-to-beat” basis [3] in order to maintain a constant laminar stress and optimize the conductance artery flow distributive function. At the same time, it is important to rely on sufficient NO release [3]. An overview of the different effects of shear stress is given in **Figure 2**.

#### 1.5. Tensegrity Structure of the Endothelial Cytoskeleton

The viscoelastic structure of the endothelial “tensegrity”-structure offers the foundation for mechano-transduction of forces. The term “tensegrity” was coined by R. Buckminster Fuller (1975) [24], architect of the geodesic dome, where discontinuous compression and continuous tension were used to achieve the highest possible stability combined with lightness. Additional anchorage points are used to transfer mechanical forces to the individual compression and tension elements [25]. The equivalents at the endothelial cell level are the three intercommunicating networks of protein filaments and their anchor points.

*Actin filaments* as the elastic part, serve to maintain the cell shape by forming a ring under the cell membrane [25] with a communication network to flow sensors (*mechano-sensors*) and membrane focal adhesion points (*FAS*)—the “*anchor points in the tensegrity model*”—as well as the intercellular *gap junctions* (*CCAP*) [25]. According to Dudek *et al.* [26], over 80 actin-binding proteins are critical participants in the generation of tensile forces. The original article [25] provides a deeper insight into this complex topic. In response to contractile stimuli, *actin- and myosin filaments* form membrane-bound, parallel organised units, called “*stress fibres*” that stimulate the sliding of myosin along

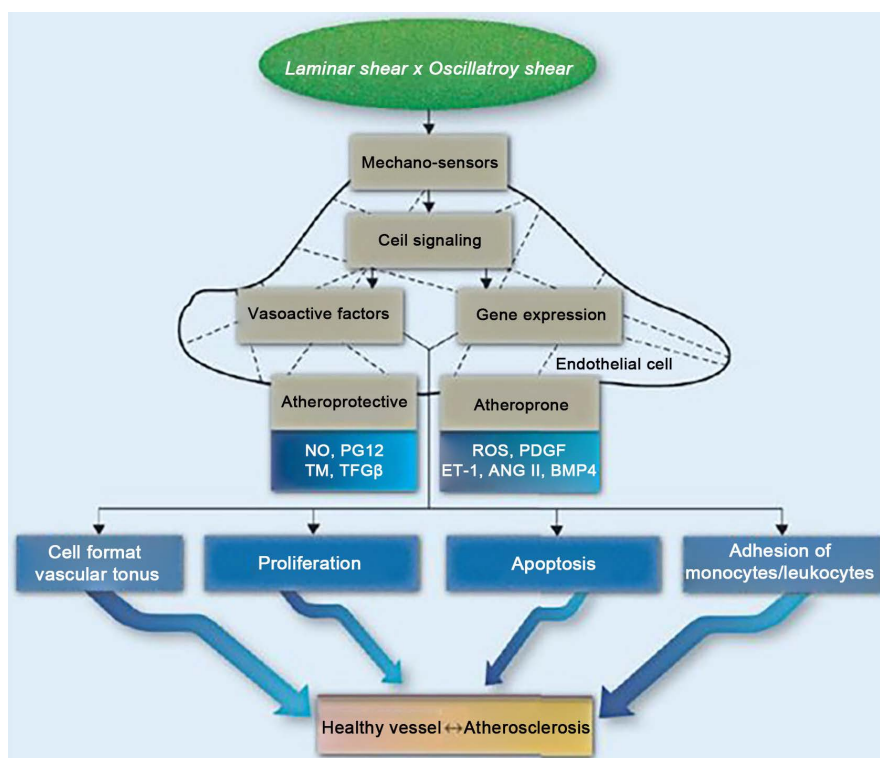

**Figure 2.** Original description: Different effects of laminar and oscillatory shear on cell function and atherosclerosis. The *dotted lines* represent the endothelial cell cytoskeleton. Laminar and oscillatory shear forces are recognized in endothelial cells by mechanosensors and the mechanosignals initiate signalling cascades that regulate the production of vasoactive factors, and the balance between these factors. While laminar shear stimulates the production of atheroprotective factors, oscillatory shear stimulates the production of atherogenic factors and the balance of these factors determines the vessel tendency to stay healthy or to develop atherogenic plaques. PGI<sub>2</sub>, prostacyclin; TM, thrombomodulin; TGF $\beta$ , Transforming Growth Factor beta; PDGF, Platelet-Derived Growth Factor; ET-1, Endothelin-1; BMP4, Bone Morphogenetic Protein 4. Adapted from Jo H, Song H, Mowbray A. Role of NADPH oxidases in disturbed flow- and BMP4-induced inflammation and atherosclerosis. *Antioxid Redox Signal* 2006; 8: 1609-19. Overview over the different effects of laminar and oscillatory shear stress on cell function and atherosclerosis. Original source [3] Fernandes CD, Araujo Thair's S, Laurindo FRM, Tanaka LY. Hemodynamic Forces in the Endothelium. Mechanotransduction to Implications on Development of Atherosclerosis. In: *ENDOTHELIUM AND CARDIOVASCULAR DISEASES. Vascular Biology and Clinical Syndromes*. Edited by PROTASIO L. DA LUZ. PETER LIBBY ANTONIO C. P. CHAGAS. FRANCISCO R. M. LAURINDO. Publisher: Mica Haley. Sao Paulo. (2018) ISBN 978-0-12-812348-5 Cap. 7 FIG 7.3, p 90. With permission.

the actin filaments. This leads to an increase in intracellular tension and thus cell contraction according Wang *et al.* (2009) [27] and Lee *et al.* (2003) [28]. The closing and opening of the paracellular gaps in response to inflammation, ischemia and invading substances (*gate-keeper-function*) is essential according to Patrick Belvitch *et al.* (2018) [29]. Actin filaments also make up the so-called *microvilli*. These contain a central bundle of actin filaments, also anchored to the cytoskeleton. Microvilli are found in various organs (e.g. intestine) where they have re-sorptive properties.



*Microtubules* constitute the compression element with pressure-resistant hollow rods, consisting of  $\alpha$ - and  $\beta$ -tubulin [25]. They are connected to the ECR by integrins (*transmembrane proteins*) and support the cellular structure in communication with actin filaments and intermediate filaments as well as the formation of spindles for mitosis.

### 1.6. Mechanical Force Transmission via “Biophysical” Mechano-Transduction

The observation that many processes obviously take place much faster than the *mechano-chemical* pathway via gene expression and protein synthesis would allow (namely minimum some seconds), led to an intensive research in the “tensegrity” structure and to the definition of the “*biophysical pathway*”. This relies on direct physical links between specific mechano-sensors of the endothelial surface and cytoskeleton elements. It allows cells to transfer mechanical stimuli over long distances and very important, a spatially heterogenic excitation to transform information in a desired reaction [27]. Crucial work with important relevance to our work, is the research on the dynamics and distribution of transmission in response to “noisy flow” from Bori Mazzag *et al.* 2010 [30] and Mazzag B, Gouget C, Hwan Y, Barakat AI 2014 [22]. By “noisy” flow, the authors mean an “*oscillating or turbulent flow under conditions with random fluctuations in the flow properties of pressure and velocity*”, Quote Mazzag, Barakat 2010 page 912 [30].

Predecessors in the exploration of the “biophysical pathway” in the early 2000’s were Wang *et al.* [8] and Davies *et al.* (2005) [31]. Significant works have been contributed in this context by Helmke *et al.* [32], Hsu, H. J., Lee, C.F, Locke, A. *et al.* (2010) [33]; Hwang, Y., Gouget, C. L. M and Barakat, A. I. (2012) [34].

To better understand the dynamics of force transmission via cytoskeletal filaments, a number of mathematical models have been developed. The authors Mazzag and Barakat present an overview (possibilities and limitations) in [22].

**The Temporal Network Model**, as presented in (2010) [30] and (2014) [22] is based on a viscoelastic structure of a tensegrity model, in order to develop insight of “noisy” flow transmission and to define which transmission structures are sensible to “noisy” flow. This model is shown in **Figure 3**.

The results show that the amplitude of the *oscillations* in the “noisy” flow will be answered more strongly than its duration. Another significant implication is that *FAS* (Focal adhesion points - equal anchoring points to ECR), due to their high sensitivity to noise, are prime candidates for acting as cellular “Noise detectors” [30].

A summary assessment follows in Mazzag 2014 [22] with further developments of models, e.g., for the spatial distribution of mechanical forces during transmission such as the **Spatial temporal network Model**; according to the authors [22], there were important contributions from the original articles from [34] and Mazzag and Barakat (2011) as well as Mazzag *et al.* (2003).

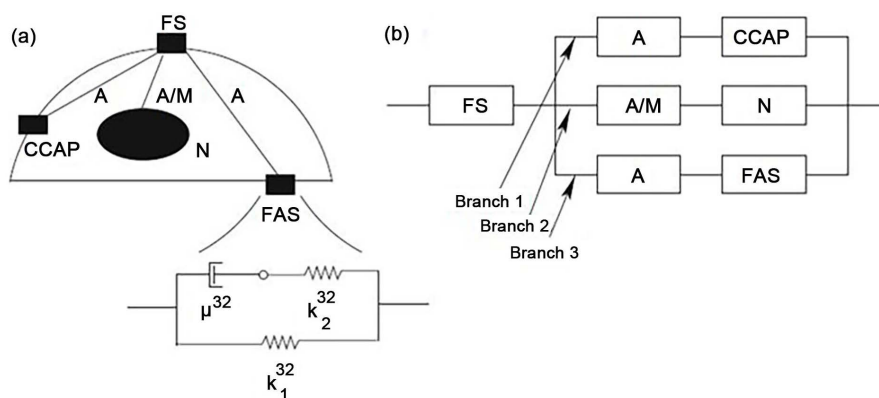

**Figure 3.** *Original description:* Schematic representation of an EC consisting of a mechanosensor (MS), cytoskeletal elements (either actin stress fibres (a) or microtubules (M)), a nucleus (N), cell-cell adhesion proteins (CCAP), and focal adhesion site (FAS). The inset shows a TPM (or Kelvin body) representation and the viscoelastic parameters for FAS. The superscripts '32' on the parameters indicate that this element is the second element on the third branch (see text). (b) Branching network representation of the EC components in panel A. Each cell component corresponds to a TPM, coupled to other components according to the diagram shown. Actin stress fibre and CCAP connected in series are referred to as Branch 1, actin stress fibre/microtubule in series with the nucleus is Branch 2, and actin stress fibre in series with the FAS is Branch 3. (a) Schematic representation of an endothelial cell consisting of a flow-sensor (FS), cytoskeletal elements actin filament (a) or microtubules (b) and the connections (N), (CCAP), (FAS). (b) Mathematical representation. Original source [22] [30]: Temporal Network Model FIG 1 *Bori Mazzag, Cecile L. M. Gouget, Yongyun Hwang and Abdul I. Barakat* (2014) [22] Cap. 5. Page 98 [30] Mechanical Force Transmission via the Cytoskeleton in Vascular Endothelial Cells. In *Endothelial Cytoskeleton*. Editors Juan A. Rosado and Pedro C. Redondo Department of Physiology, University of Extremadura Cáceres, Spain. With permission.

In summary, *the results provide the strong frequency dependence of force transmission with definition of a threshold value for actin filaments (more sensible) and microtubules.*

Another issue for the authors was the saturation behaviour when the signal persists and an explanation, as to why the natural frequencies, generated by organs of the organism itself, do not lead to a long propagation of transmission. We cite the authors Mazzag and Barakat 2014 p. 107 [22]:

*“In the case of oscillatory forcing, the deformation-related stress as in the case of constant forcing, exhibits an initial transient before it eventually saturates to a time-periodic steady state response. Importantly the saturation amplitude of the deformation-related stress at the nucleus is found to be strongly dependent on the forcing frequency. Figures 3D and E illustrate the saturation amplitude of deformation-related stress at the nucleus as a function of forcing frequency for transverse and axial forcing, respectively. In both the axial and transverse directions, a low-frequency (<0.1 Hz) mechanical stimulus is transmitted to the nucleus without decay in its amplitude, whereas a high-frequency mechanical stimulus undergoes significant decay in amplitude. This implies that individual stress fibres act as low-pass filters of mechanical forcing. Interestingly, transverse motion exhibits a much broader filter width than axial motion: the filter width*

for transverse motion extends to  $f \sim 1000$  Hz whereas the one for axial motion extends to only  $f \sim 1$  Hz” [...] (Remarks: citation italic letters).

Second important quote page 101 [22]:

“As already described, oscillatory flow has been reported to induce EC dysfunction and to correlate with the development of early atherosclerotic lesions. Therefore, we also investigated the response of the simple networks described in the previous paragraph to oscillatory flow. The results revealed that the peak deformation (defined as the largest deformation within a period after the asymptotic time-periodic behaviour is attained) of each of the structures in the network (mechano-sensor, actin stress fibres, microtubules and nucleus) is strongly frequency-dependent. At sufficiently low oscillatory frequencies, the peak deformations match those for constant forcing; however, above a threshold frequency, the peak deformations drop significantly. The analysis demonstrated that this threshold frequency is in the range of  $10^{-5}$  -  $10^{-4}$  Hz for microtubules and  $10^{-3}$  -  $10^{-2}$  Hz for actin stress fibres, suggesting that stress fibres can effectively transmit force over a wider frequency range.” [...]” [Remarks: Italic letters from me]

Experimental researches by Na *et al.* (2008) [35] were experimentally comparing the velocity of mechano-transduction via the *bio-physical* and via the *mechano-chemical* pathway (*growth factor and gene expression*). The authors used comparable physical exposures for Infrasound (0.3 Hz), duration 30 s, sound pressure 1.8 Pa (studies with 1.8 Pa up to about 20 Pa). The most important results were the confirmation that the speed was 40 times faster than by mechanical-chemical means (confirming the above results), namely 300 ms (milliseconds). Beyond this, the findings were that the “*Stress-Induced Src Activation depends on Integrin Activation, Substrate Stiffness, Prestress and F-Actin Integrity*” [35], quote from Na *et al.* page 1. Remarks: in italic letters (from me) [35].

### 1.7. The Mechano-Sensors of the Endothelial Cell

According to [3] the cytoskeleton itself is a mechano-sensor. On the side facing the vessel (luminal), mechano-sensors are especially the *glycocalyx*, *integrins*, *cell-cell junctions (CCAP)*, *caveolae*, *lipid rafts*, *G-protein coupled receptors and ion channels*. They are activated according to their location via shear stress [3] (Figure 4). According to the author [3], endothelial mechano-sensors are altered in their microenvironment by shear stress and can activate intracellular signalling pathways in this new formation. The fluidity of microdomains in the plasma membrane is altered [3]. This leads according to [3] to a spatial rearrangement of various proteins and thus to the activation of signalling pathways. The *transmission of forces* takes place via the three intercommunicating networks of the cytoskeleton to the basal region of cytoskeleton (e.g., Integrins) [3] [22] [30].

One of the most important mechano-sensors is the *glycocalyx* ([1] [3] Figure 4). In critically ill patients the extent of the *glycocalyx* damage (so called *shedding*) correlates with the severity of disease and mortality [1] [36] [37].

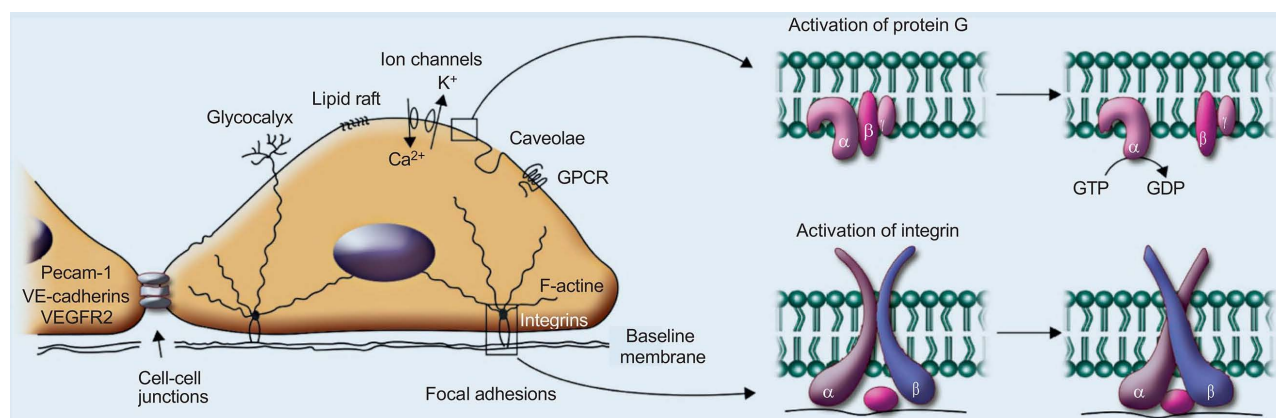

**Figure 4.** *Original description:* Endothelial cell mechanosensors. Location of mechanosensors such as cytoskeleton, integrins, cell-cell junctions, caveolae, lipid rafts, cell surface glycocalyx, G protein-coupled Receptors (GPCR), and ion channels. While mechanosensors in the apical region (luminal) are activated directly by shear stress (such as G proteins), the cytoskeleton (represented by actin fibres, F-actin) is responsible for transmitting forces to the mechanosensors at the basal region of endothelial cells (such as integrins). G protein activation occurs due to local changes in plasma membrane fluidity, therefore directly due to shear stress and independent from an agonist, causing hydrolysis of GTP into GDP. On the other hand, the structure of mechanosensitive integrins is changed from inactive to active when submitted to shear stress, possibly due to transmission of the mechanical force to the cytoskeleton. In active conformation, integrins have higher affinity for cognate proteins in the extracellular matrix. Mechano-sensors of the endothelial cell (status 2019) Original source [3] Fernandes CD, Araujo Thar's S, Laurindo FRM, Tanaka LY. Hemodynamic Forces in the Endothelium. Mechanotransduction to Implications of Development of Atherosclerosis. In: ENDOTHELIUM AND CARDIOVASCULAR DISEASES. Vascular Biology and Clinical Syndromes. Edited by PROTASIO L. DA LUZ, PETER LIBBY ANTONIO C. P. CHAGAS, FRANCISCO R. M. LAURINDO. Publisher: Mica Haley. Sao Paulo (2018) ISBN 978-0-12-812348-5. Cap. 7 FIG 7.2, p. 89. With permission.

Like identified to date, mechano-sensors are presented in **Figure 4** (status 2019).

### 1.8. PIEZO-1-Channels

Additional recently defined endothelial mechano-sensors, the PIEZO-1 channels, have been clearly established *as a sensory system of internal organs* by the receptors for pressure and vibration in all vessels. Due to the great importance of their breakdown, Ardem Patapoutian received the Nobel Prize in Medicine 2021. According to Rode *et al.* (2017) [38], Piezo-1 is responsible for flow-sensitive, non-inactivating, non-selective cationic channels which depolarize the membrane potential:  $\text{Ca}^{2+}$  permeable Piezo-1 channels are activated by physical force on the cell membrane (compare **Figure 5**). PIEZO-1 sense whole body's physical activity to reset cardiovascular homeostasis and enhance performance. They are critical for lymphogenesis and homeostasis and are important shear stress mechano-sensors [39]. PIEZO-channels are crucial in all multicellular organisms, *i.e., also invertebrates such as flies and vertebrates (fish)* [40]. A schematic representation of an embedded PIEZO-1 channel is shown in **Figure 5**.

## 2. Noise, Sound and Infrasound

In the International Classification of Diseases (ICD-10) (2010), published by the World Health Organization (WHO), "Noise exposure" (item W42) is listed

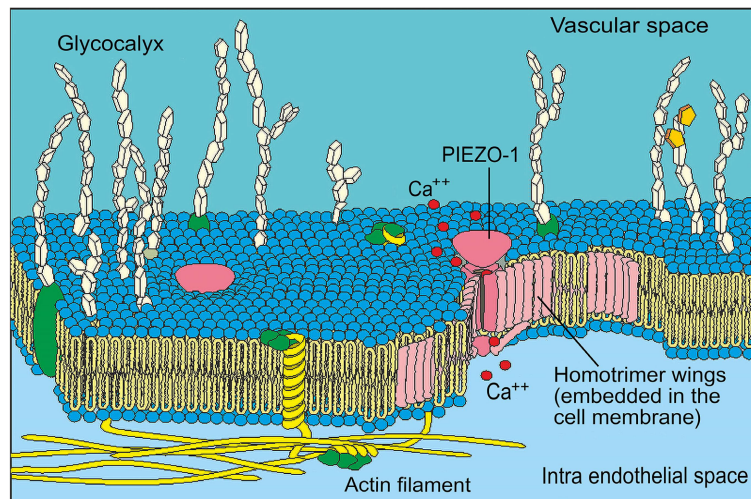
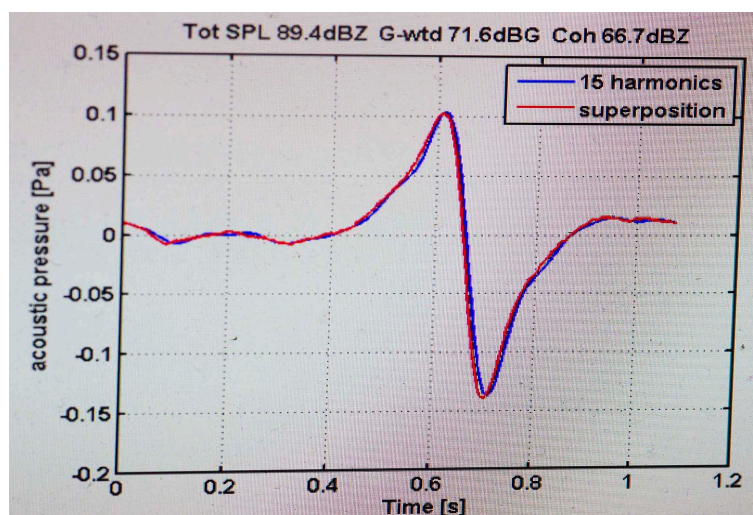

**Figure 5.** Schematic presentation of a PIEZO-1-channel, embedded in the endothelial cell membrane with a triggered  $\text{Ca}^{2+}$ -inflow. The actin ring (intra-endothelial) is indicated. The wings are moved by mechanical forces on the membrane and release the channel in an opening movement. Blue/Yellow: endothelial bio membrane with lipid bilayer structure. Schematic presentation of a PIEZO-1-channel.

under the heading of “Exposure to inanimate mechanical forces” (items W20-W49) [41]. Indeed, airborne propagating pressure waves (*i.e.*, sound) impact the *viscoelastic tissue* of biological organisms as external mechanical forces.

In the more recent ICD-11 (2020), additional Extension Codes (Section X) have been established and “noise exposure” (item XE7Y1) now falls under the categories of “External causes/Exposure to other mechanism” [42]. The condition “Vertigo from infrasound” (item T75.2 in the ICD-10) under the heading “Effects of vibration” now falls under the category of “Other specified effects of vibration” (item NF08.2Y).

Infrasound is defined as sound with frequency below 20 Hz. Low frequency noise (IFLN), not clearly defined, according to DIN 45680, draws the line at 125 Hz. The lower the frequency, the greater the wavelength. Infrasound can only be minimally dampened, is less attenuated by propagation through the atmosphere as well as through roofs and walls than the audio spectrum. For example, sound propagation in air with a wave length of 0,1 Hz is about 3,3 km (standard condition 20-degree Celsius), that of 1000 Hz is about 34 mm. Infrasound is generated by heavy moving masses as well as by resonance phenomena/vibration. Its exposure can be occupational or residential, can be emitted from natural (e.g., earthquakes) or technical sources (trains, airplanes, occupational or residential sources). The emitters differ in frequency, sound pressure P (Pa), time/effect profile (impulsiveness) and duration. According to increasing numbers and size of IWT rotors, therefore complaints increase especially [43]. The larger the rotor, the lower the emitted frequency. Infrasound of IWT’s is meanwhile with big parts in the range of 0.1 to 10 Hz according to [44] [45]. Its infrasound emission is impulsive in the effect/time profile according to Roos W, Vahl, CF (2021) [45] and Vanderkooy [46], as shown in **Figure 6**.



**Figure 6.** An infrasonic pulse extracted from the emission of a wind turbine. The fluctuations of sound pressure measurable near a wind installation usually contain noise, *i.e.* irregular sound events of different origin. Noise removal is possible by averaging the sound pressure over a large number of mast-blade passages (here 4100), which reveals their common element (red line). The red peak thus visualized from the time sequence coincides with the blue peak, which shows the fundamental pulse as reconstituted in the frequency domain from 15 (very sharp) harmonic lines by Fourier analysis. The result is the coherent fundamental peak of this turbine of 0.9 Hz frequency, accordant to 1.08 seconds required per blade passage. Extracted infrasonic pulse of a wind turbine showing the relation between sound pressure (P) and time (s). Original source [46] corresponding to **Figure 7** Vanderkooy<sup>1</sup> J, Mann<sup>2</sup>, R Measuring Wind Turbine Coherent Infrasound Department of Physics and Astronomy 1, Department of Computer Science 2 University of Waterloo, Waterloo, ON, Canada, N2L3G1 [jv@uwaterloo.ca](mailto:jv@uwaterloo.ca), [mannr@uwaterloo.ca](mailto:mannr@uwaterloo.ca) Date posted: 2 October, 2014. With permission.

The physical laws of wave theory apply to the propagation of sound, *e.g.*, as longitudinal or transverse wave and with different velocities of propagation (in fluid medium about three times as fast as in gas). The propagation behaviour depends on the various elastic media, whether liquid, gaseous, solid or a mixture thereof; the same applies to the viscoelastic organism. Since sound is a mechanical wave, the propagation can be refracted, reflected, can interfere and can be transmitted [47]. The propagation of a wave is a transport of energy, but not a transport of material. During propagation, particles are set into oscillation. Furthermore, in indoor spaces of buildings, interferences of airborne sound pressure and structure-borne sound are possible, which can lead also to relevant amplifications or attenuations of the total impacting sound [48].

### 3. The Hypothesis/Theory

#### 3.1. The Difference from Current Thinking

The existing epidemiological studies almost exclusively consider the audio-vestibular organ, respectively the involvement of individual brain structures [49], as organs, possibly affected by exposure to noise in low-frequency ranges. In comparison with electromagnetic fields, everybody accepts that impacts on

organism are not depending on a perception. Why not here? This question has already been asked in 2007 [50]. Many health disorders or manifest clinical symptoms cannot be explained with purely audio-vestibular impact. Since around 2015, the author noticed many complaints worldwide by the residential situation. They are corresponding to functional microcirculatory disorders according to a reduced and uncoordinated *NO-bioavailability*.

These are, e.g., dizziness, school performance disorder, fatigue, tinnitus, muscular weakness and headaches as signs of a disturbed and inadequate support with nutrients and O<sub>2</sub>. With chronic exposure, symptoms occur such as increased blood pressure, cardiac arrhythmia, breathing disorders, immune deficiencies, late-onset epilepsy [50]. In a second step a working hypothesis was developed that tested the prerequisites for a direct stressor effect on both, the endothelial cell level and the technical side. The results, available to date from epidemiological studies, experimental and animal experimental studies, were included in the considerations.

In a third step the currently available literature on molecular endothelial physiology and pathophysiology was reviewed with regard to the possibility of mechano-transmission of mechanic forces if outgoing from an extern acting stressor. The identification of PIEZO-1-channels 2021 as important mechano-sensors for sound and vibration strengthened the evidence for our hypothesis. Extensive literature on pathohistological findings in occupational exposure to infrasound from the 1980s [50], later from the 2000s on exposure of residents to wind turbines [51] and the reassessment of these findings were included.

Due to the audio-acoustic approach, the changed conditions for sound propagation in the viscoelastic organism did not have been considered in the past. We do now. *For the same reason, it makes the so-called perception threshold irrelevant as this only refers to audible sound and air transmission.*

### **3.2. The Hypothesis Is Based on the Evidence for:**

- Noise is a mechanical force, therefore subject to physical laws;
- The existence of numerous mechano-sensors for sound and vibration at the membrane/endothelial level with newly identified, in particular endothelial PIEZO-1-channels, is state of the science;
- Mechano-transduction of mechanical forces is crucial for many vital vascular regulations;
- The mechanical transmission of forces via the structures of the endothelial cytoskeleton is state of the science;
- Proven microtactile excitability of endothelial cells with rapidly propagated conduction up- and downstream.

### **3.3. Our Hypothesis**

- Noise, when it affects organisms, is under certain conditions in frequency, sound pressure, effect/time profile, duration, able to change the physiological laminar flow situation in the capillary bed in the sense of an oscillatory envi-

ronment. In this case, the transition of mechanical forces might take place in an uncontrolled manner;

- In consequence vasomotor functions and in particular vasomotion could be disturbed;
- The expected effects of chronic impact could lead to a chronic inadequate nutrient supply and therefore to a shift of equilibria to disequilibria, especially for the redox systems and for the responses to inflammation processes.

#### 4. Evaluation of the Hypothesis

The first basic condition that applies to our hypothesis is the question, of whether exposure to “Noise”, in the sense of an oscillatory stressor, causes an oscillatory field in the capillary bed in turn.

##### 4.1. Positive Support for Evidence

The evidence for this is supported by the responsiveness of endothelial mechano-sensors for external influences such as gravity, pressure, swelling, noise [1] [3] [22] [30] as well as the microtactile excitability of endothelial cells [5]. There is also evidence that infrasound interacts with cell metabolism and leads to perivascular fibrosis in *Infrasound induces coronary perivascular fibrosis in rats* according to Lousinha (2018) [52]. Similar findings are presented in [53] [54] [55]. Empiric data's in experimental studies show clear indications that exposure to IFLN leads to an ROS-increase [56]. Positive evidence also indicates the study of Chaban *et al.* [57] and very noteworthy, the direct cell effect is shown in *Effect of infrasound on the growth of colorectal carcinoma in mouse* [58]. In clinical medicine, there are currently considerations about the possible benefits of infrasound in the therapy of human colon carcinoma. High evidence for a direct cell and membrane effect are the results of the review of Roos, W and Vahl, CF (2021) [45] which focus on the evidence for interaction of cellular structures, resp. sensible membrane structures, in a stress reaction. A possible disturbance of microcirculation is discussed. A positive evaluation in this direction is also the meta-analysis Dumbrille, A *et al.* (2021) [59]: This evaluation results in the causality of adverse health effects (ADH's) and the stressor in all “Bradford Hill criteria”. Reported were adverse effects on animals which revealed not only stress reactions but also negative effects on fertility, development and reproduction [60]. With regard to the Bradford-Hill criterion dose response, analyses showed a demonstrable deterioration in mental performance from residents, living within 1.4 km of wind turbine(s) to those living outside this radius [61]. Increased complaints raised when the frequencies approach deeper ones (in the mentioned example 0.2 Hz) [62].

Positive evidence for the frequent occurrence of atrial fibrillation is presented in the “*nurse cohort study*” [63]. My statement here: The development of atrial fibrillation in the absence of hypoxemia corresponds with structural changes and therefore conditions for disturbances of the electromechanics.



## 4.2. Reassessment of Pathohistological Findings

Research [50] on the symptomatology of occupationally with IFLN confronted groups in the 1980s showed wall thickening of vessels. According to the authors animal studies showed abnormal amount of fibrosis/collagen in trachea, lungs and pleura; damaged (sheared) tracheal and bronchial cilia; fused actin-based microvilli of tracheal and bronchial brush cells. Thickening of the pericardial wall has been observed in occupationally exposed persons to ILFN [50] and in persons living in the vicinity of large IWT plants [51] as a specific alteration. **Figure 7** shows pericardial wall thickening in chronic occupationally exposed persons in the eighties (so called *Vibroacoustic Syndrome* “VAD-syndrome”) in comparison to non-exposed.

**Figure 8** is the presentation of a non-exposed bronchial epithelium of a rat in comparison to an exposed one in **Figure 9**. The figures are showing the changes in the microvilli (actin) before and after exposure. The interpretation of these findings suggests a shift in the homeostasis of the redox system towards chronic inflammation and fibrosis.

## 4.3. Possibly Negative Support for Evidence

The choice of sound pressure levels (SPL) in dB in experimental studies, is often higher than expected from IWT’s installations.

Objection:

a) The SPL in dB(A) can only map airborne noise in the frequency part of hearing ( compare cap. 2).

b) The effect of the steady drip when living nearby emissions must be considered as strong factor [64], the exposure time in reality often can be (also for sensitive groups) 24/7 hours/a day. In contrast, the time in animal experimental studies is limited for practical reasons. Similar applies to the higher sound pressures in the context of occupational exposure: Here, the times of exposure are limited; sensitive groups have no access.

*However, the decisive factor is that the frequency of Noise was not recognised in its significance (e.g., use of 8 Hz in Chaban et al. [57]).* Added to this: The behaviour of sound propagation in the viscoelastic organisms differs in that way, that a decodable information about the lowpass filters becomes conceivable (compare cap. 2) [22] [30] [35].

Exemplum Poulsen-Study [65]: As result, he found no statistically significant association between exposure to infrasound and the incidence for cardiovascular diseases. A relativization of the study took place by the author himself (e.g., study on relatively little IWT’s).

## 4.4. Evaluation on Computational Studies

Important parts of the statements from Mazzag and Barakat 2010 [30] and 2014 Mazzag et al. [22] are based on computational models. As already mentioned, the authors themselves refer to possible limitations and results.

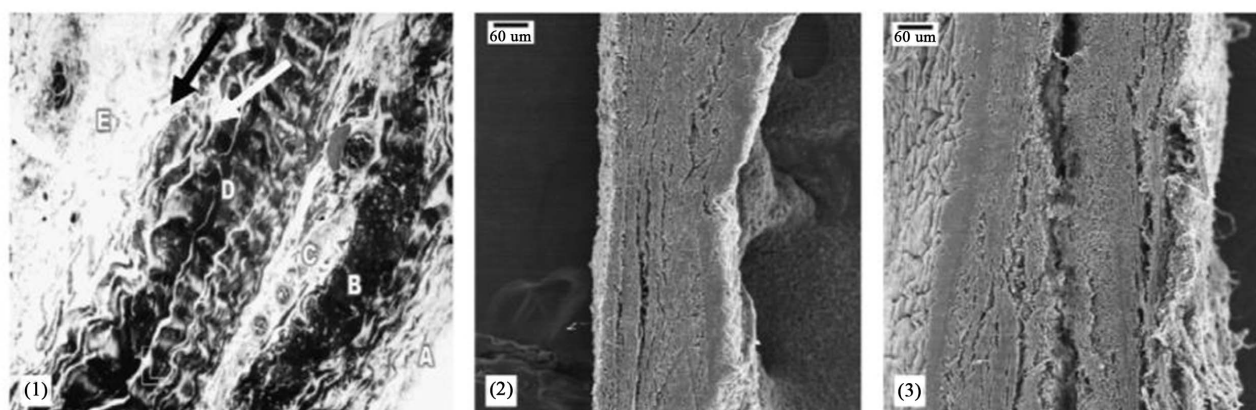

**Figure 7.** *Original description:* Light microscopy (100 $\times$ )—VAD patient pericardium, with pericardial sac on right. Five (instead of the normal three) layers are identifiable: (A) mesothelial, (B) internal fibrosa, (C) loose tissue, (D) external fibrosa, and (E) epipericardium. The loose tissue is rich in vessels. No inflammatory cellularity was identified in any of the five layers. In both fibrous layers, wavy collagen bundles are visible, however the wave length of fibres in layer B (internal fibrosa) is smaller than that in layer D (external fibrosa). Taking together the increased amount of collagen bundles, in wavy, accordion-like arrangements, with different orientations in relation to each other, and with more than one elastic fibre accompanying the bundles at seemingly perpendicular angles (seen through electron microscopy, not shown), seems to suggest a pneumatic-like structure, designed to absorb abnormally large external forces. Similarly, this functional arrangement also explains why there is no diastolic dysfunction, despite the thickened pericardial walls. (2) SEM of non-VAD patient pericardium. Normal three layers are visible: mesothelium (white arrow), fibrosa (black arrow) and epipericardium. (3) SEM of VAD patient pericardium. Fibrosa has split into two halves (arrows) that sandwich a newly formed layer of loose tissue (L). Note that the scale in both (2) and (3) is the same. The wavy form of collagen bundles is a mechanically energy-efficient method to deal with the movement that the fibrosa must constantly undergo to follow the rhythm of the cardiac cycle. Similar to an accordion, collagen bundles will extend and contract in diastole and systole, respectively. However, during an episode of sudden and violent tachycardia (common in VAD patients), this rhythm can be greatly increased (up to 200 beats per minute, in a matter of seconds) and the mechanical stress imposed on the MC monolayer may threaten its structural integrity. One of the functions of the loose tissue layer must certainly be blood and nutrient supply to this much larger organ. Remarks: ultrastructure micrographs, obtained with scanning (SEM) and transmission (TEM) electron microscopy. Pericardial wall in exposed and non-exposed persons 1) exposed (Light microscopy) 2) non-exposed (SEM) and 3) exposed (SEM) [50] Alves-Pereira M., Branco C. (2007) Vibroacoustic disease: biological effects of infrasound and low-frequency noise explained by mechanotransduction cellular signalling <http://www.sciencedirect.com/science/article/pii/S0079610706000927>. Page 11 FIG 2. With permission.

Quote from authors [22] Page 96: “*Therefore, it is essential for models to be validated to the extent possible against experimental data. It is only after such validation is performed that mathematical models can potentially fulfil their promise of providing powerful and predictive tools for studying the dynamics and spatiotemporal organization of mechanically-induced responses in cells*”.

My statement: Several predecessors [27] [33] [34] [35] have done essential preparatory work over years with high evidence; the whole process of mechanotransmission is highly dynamic with numerous pathways interlocking. Computational models are necessary to achieve the best possible approximation of dynamic processes to improve understanding of cellular mechano-transduction. The further work from Na (2008) [35] as an experimental study is one of the required experimental studies, which confirms the mathematical models. Studies in this direction have not taken place on infrasound emitting technical sources.

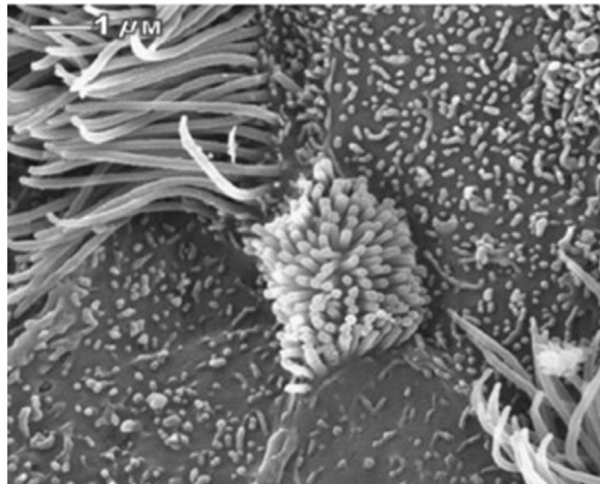

**Figure 8.** *Original description (SEM) Non-exposed bronchial epithelium. The BC in the centre of the image exhibits a tuft of microvilli that are individually identifiable, uniformly distributed, and sprouting upward into the airway. Surrounding the BC are SC with microvilli of different sizes. Tufts of cilia featuring vesicles are also visible. No sheared, shaggy or wilted cilia are visible SEM). No oedema is present. BC (brush cells), SC (Secretory cells). Rat bronchial epithelium, exposed to 2160 h of continuous IFLN.*

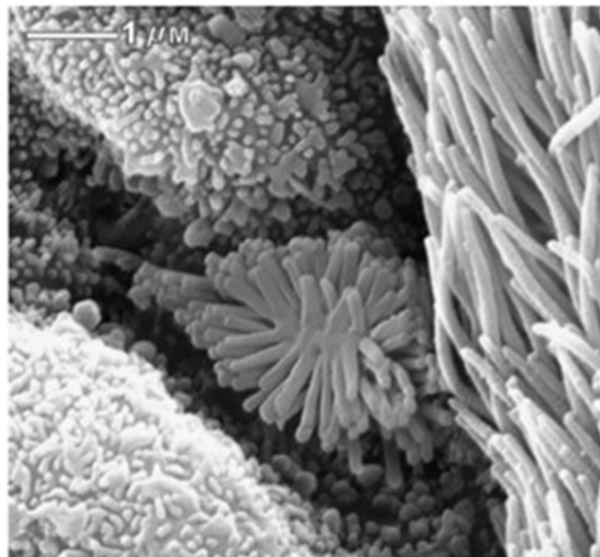

**Figure 9.** *Original description (SEM) Rat bronchial epithelium exposed to 2160 h of continuous IFLN. A BC is in the centre of the image. Its microvilli are not sprouting upward and, instead, have fused, forming a central indentation that seems to be spreading outward. The prominent SC that surround the BC are swollen forming deep valleys at the intercellular junctions. SC microvilli are very irregular. Ciliary vesicles are visible. Ultra-structure micrographs, obtained with scanning (SEM) and transmission (TEM electron microscopy. BC (brush cells), SC (Secretory cells). Rat bronchial epithelium, exposed to 2160 h of continuous IFLN.*

#### 4.5. Additional Extrinsic Regulation of Microcirculation

The influence of the extrinsic part on vasomotor function via the autonomic nervous system is the variable part that strongly depends on the individual abili-

ties to compensate for stress factors. It is an additional influencing factor that is probably the reason why people in the same environment do not react in the same way in their symptomatology. The following can be expected when comparing a short-term stressor load with a permanent one: After an individual period of time, the compensation possibilities of biological systems are exhausted.

#### 4.6. Proposed First Research and Methods

For further confirmation, we propose an experimental design with a determined number of infrasound exposed probands in comparison to non-exposed subjects. The positive group is exposed to a defined infrasound stressor in frequency, sound pressure  $p$  in (Pa), time/effect profile (impulsiveness) and duration. The design is double-blinded, in on/off design under SDF-video-microscopy technique, examining the *sensible vasomotion* via oral mucosa. Corresponding animal experiments are conceivable with regard to the assessment of direct vasomotor changes under infrasound (e.g. in hamsters via the cheek). The indications of changes in animal behaviour as well as reproductive behaviour in vertebrates and non-vertebrates would be a meaningful addition and extension of further scientific clarification.

#### 4.7. Importance of Our Research

Vascular health is strictly combined with *NO bioavailability*. Of great importance for its maintaining, is the classification of possible damaging environmental factors. The particularly sensitive population groups must be the bench. Our hypothesis can help to define sensitive stages for mechano-transmission of deep frequencies of “Noise”.

### 5. Established Methods to Assess and Visualize Microcirculatory Processes

The microcirculation can be visualised *in-vivo* on new-born babies via the skin, on adults via the oral mucosa [1]. Changes, especially in *vasomotion*, can be detected immediately and are reproducible. Appropriate techniques are video microscopy techniques such as *SDF (side stream dark field)* imaging. A better visualization of the microcirculation *in-vivo* has become possible [66]. The microcirculation in the context of diseases can be visualized and quantified immediately after exposure to the stressor, as well in its absence. Parameters that can be specifically observed include:

- *The intact vasomotion in first order*
- *An instantaneously changing in vasomotion under defined stressor effect*
- *The functional blood vessel density (FVD) ( $mm/mm^2$ )*
- *The red blood cell flow velocity (RBCV)*
- *The number of perfused capillaries (N/A) ( $n/mm^2$ )*
- *The capillary vessel diameter (DM)*
- *The glycocalyx thickness in  $\mu m$  (conceivable for further research projects)*

## 6. Proposed Research Avenues; Questions Regarding Target

- Under which defined conditions does noise with certain properties affect the mechanical transduction of signals at the cellular level (e.g. membrane components, cytoskeleton) and/or the cell-cell interaction?
- Which mechano-sensors, defined structures, are specifically sensitive? Which role play PIEZO-1-channels?
- Which sound pressure is required at a certain frequency to obtain a transfer response?
- Which specific role plays resonance effects?
- What is the specified role of PIEZO-2-channels for the perception of deep frequencies?
- Which parameters can be found to demonstrate the emerging imbalance of the redox system and at the same time distinguish the aggravation of atherosclerosis in its causes?

## 7. Conclusions

For the first time, the symptomatology of chronically infrasound exposed humans and animals can be classified pathophysiologically in a coherent hypothesis. This was made possible by the progress in knowledge of endothelial mechano-transduction, essential as vascular function of vital character in response to mechanical forces. Crucial cellular processes such as growth, differentiation, migration, angiogenesis, redox homeostasis and inflammation, are simultaneously dependent on mechanical forces and the integrity of the endothelium.

Normally, the flow in the mammalian microcirculation is laminar and not variable. This is achieved by the upstream connection of the resistance vessels in the arterioles. Persistent changes in shear stress patterns, particularly oscillatory flow, have been associated with decreased bioavailability of NO, an increase in reactive oxygen species (ROS), higher lipoprotein oxidation rates, increased endothelial apoptosis, pro-atherogenicity, chronic inflammation and possible development of cancer. We have positive evidence for our hypothesis that a chronically acting oscillating stressor with certain conditions in frequency, time/effect profile, sound pressure and duration might induce an oscillatory stress field and therefore trigger a stress reaction on the cellular level. With the crucial basics of mechano-transduction, there is now a strong evidence with obvious indicators for a possible interaction of infrasound, especially with deep frequencies and impulsive character, as have, e.g., IWT's or heat pumps. The elucidation for the strong dependency on mechano-transduction from the frequency of "Noise" and the identification of actin filaments and microtubules as "low-pass filters", support our hypothesis. In this way, the propagation of sound wave in the viscoelastic organism could become a decodable information. Regeneration, as would occur with a one-time or infrequent exposure, could not take place with chronic impact. Initially functional disturbances of the orchestrated vasomotor system, respectively of sensible *vasomotion*, can be expected, with longer exposure fixed

anatomically recognisable pathological damages in endothelial integrity. Important in this context are the structural changes that tend to be self-reinforcing, as described in the example of remodelling of the heart. By probably elucidating the pathophysiological pathway of how infrasound/IFLN could lead to the main health disorders, it will be possible to make steps forward in defining safe distances for living or working with emitting technical installations. Many scientific questions remain to be answered, but there is sufficient evidence to suggest that, as precautionary measurements, further technologies, involving very low frequencies and/or impulsive emissions with potential impact on living organisms, should be limited or better avoided until all issues are scientifically resolved. The possible effects on insects, which have not been clarified yet, could be of great importance, e.g., for the biodiversity and for co-affection of pollinators and thus nutrition.

The decoding of the PIEZO-1-channels should have already alerted public to the potential risks. Inner organs are sensitive for sound and vibration. The current state of knowledge on mechano-transduction together with known oscillatory and oxidative stress effects, point in the direction of our hypothesis and should be reason for urgent precautionary actions and further research.

### **Acknowledgements**

I thank Prof. Dr. Werner Roos, emeritus Head of Pharmaceutical Biology at Martin Luther University in Halle, for his critical review and constructive contributions. I thank Manfred Krueger, Berlin, Graphic designer for Graphic **Figure 5**.

### **Disclaimer**

For the author there are no conflicts of interests. The author would like to clarify that: Alternative forms of renewable energy such as industrial wind turbines are considered as worthwhile additions at suitable locations. The same is valid for biogas installations, heat pumps, block-type thermal power stations. The data reported herein have been scrutinized under one, and only one agenda, that of pure scientific inquiry. There are no commercial, financial or professional agreements.

### **Conflicts of Interest**

The author declares no conflicts of interest regarding the publication of this paper.

### **References**

- [1] Nussbaum, C.F. (2017) Neue Aspekte der Mikrozirkulation im Rahmen von Entzündung, Entwicklung und Erkrankung. Kumulative Habilitationsschrift zur Erlangung der Venia Legendi. Fach Pädiatrie. Ludwig-Maximilians-Universität München. Kinderklinik und Kinderpoliklinik im Dr. von Haunerschen Kinderspital. München.

- [2] Sperando, M. and Brandes, R. (2019) Kap. 20. Mikrozirkulation. In: Brandes, R., Lang, F., Schmidt, R.F., Eds., *Physiologie des Menschen mit Pathophysiologie*, Springer, Vol. 32, 241-256.
- [3] Fernandes, C.D., Araujo Thais, S., Laurindo, F.R.M. and Tanaka, L.Y. (2018) Cap. 7. Hemodynamic Forces in the Endothelium. Mechanotransduction to Implications on Development of Atherosclerosis. In: Da Luz, P.L., Libby, P., Laurindo, F.R.M. and Chagas, A.C.P., Eds., *Endothelium and Cardiovascular Diseases. Vascular Biology and Clinical Syndromes*, Mica Haley, Sao Paolo, 85-94.
- [4] Durán, W.N., Sánchez, F.A. and Breslin, J.W. (2011) Microcirculatory Exchange Function. In: *Comprehensive Physiology*. Program in Vascular Biology, USA.
- [5] de Wit, C., Wöfle, S.E. and Höpfl, B. (2006) Connexin-Dependent Communication within the Vascular Wall: Contribution to the Control of Arteriolar Diameter. *Advances in Cardiology*, **42**, 268-283. <https://doi.org/10.1159/000092575>
- [6] Moore, P.R., Dyson, A., Singer, M. and Frazer, J. (2015) Microcirculatory Dysfunction and Resuscitation: Why, When, and How. *British Journal of Anaesthesia*, **115**, 366-375. <https://doi.org/10.1093/bja/aev163>
- [7] Voets, T. and Nilius, B. (2009) TRPCs, GPCRs and the Bayliss Effect. *The EMBO Journal*, **28**, 4-5. <https://doi.org/10.1038/emboj.2008.261>
- [8] Chien, S. (2007) Mechanotransduction and Endothelial Cell Homeostasis: The Wisdom of the Cell. *The American Journal of Physiology-Heart and Circulatory Physiology*, **292**, H1209-H1224. <https://doi.org/10.1152/ajpheart.01047.2006>
- [9] Jones, T.W. (1854) Discovery That the Veins of the Bat's Wing Are Endowed with Rhythmical Contractility, and That Onward Flow of Blood Is Accelerated by Each Contraction. *Philosophical Transactions of the Royal Society of London*, **142**, 131-136. <https://doi.org/10.1098/rstl.1852.0011>
- [10] Aalkjaer, C. and Mulvany, M.J. (2020) Structure and Function of the Microcirculation. In: Agabiti-Rosei, E., Heagerty, A.M. and Rizzoni, D., *Microcirculation in Cardiovascular Diseases*, Springer, Berlin, 1-14. [https://doi.org/10.1007/978-3-030-47801-8\\_1](https://doi.org/10.1007/978-3-030-47801-8_1)
- [11] Laurindo, F.R.M., Liberman, M., Fernandes, D.C. and Leite Paulo, F. (2018) Cap. 8. Endothelium-Dependent Vasodilation: Nitric Oxide and Other Mediators. In: Da Luz, P.L., Libby, P., Laurindo, F.R.M. and Chagas, A.C.P., Eds., *Endothelium and Cardiovascular Diseases. Vascular Biology and Clinical Syndromes*, Mica Haley, Sao Paolo, 97-98.
- [12] Espey, M.G., Miranda, K.M., Thomas, D.D., Miranda, K.M. and Wink, D.A. (2002) A Chemical Perspective on the Interplay between NO, Reactive Oxygen Species, and Reactive Nitrogen Oxide Species. *Annals of the New York Academy of Sciences*, **962**, 195-206. <https://doi.org/10.1111/j.1749-6632.2002.tb04068.x>
- [13] Wink, A.A. and Mitchell, J. (1998) Chemical Biology of Nitric Oxide: Insights into Regulatory, Cytotoxic, and Cytoprotective Mechanisms of Nitric Oxide. *Free Radical Biology and Medicine*, **25**, 434-456. [https://doi.org/10.1016/S0891-5849\(98\)00092-6](https://doi.org/10.1016/S0891-5849(98)00092-6)
- [14] Augusto, O., Bonini, M.G., Amanso, A.M. and Linares, E. (2002) Nitrogen Dioxide and Carbonate Radical Anion: Two Emerging Radicals in Biology. *Free Radical Biology and Medicine*, **32**, 841-859. [https://doi.org/10.1016/S0891-5849\(02\)00786-4](https://doi.org/10.1016/S0891-5849(02)00786-4)
- [15] De Wit, C., Hoepfl, B. and Woelfle, S.E. (2006) Endothelial Mediators and Communication through Vascular Gap Junctions. *Biological Chemistry*, **387**, 3-9. <https://doi.org/10.1515/BC.2006.002>
- [16] Suthahar, N., Meijers, W.C., Silljé, H. and de Boer, R. (2017) From Inflammation to Fibrosis-Molecular and Cellular Mechanisms of Myocardial Tissue Remodelling

- and Perspectives on Differential Treatment Opportunities. *Current Heart Failure Reports*, **14**, 235-250. <https://doi.org/10.1007/s11897-017-0343-y>
- [17] Ley, K., Laudanna, C., Cybulsky, M.I. and Nourshargh, S. (2007) Getting to the Site of Inflammation: The Leukocyte Adhesion Cascade Updated. *Nature Reviews Immunology*, **7**, 678-689. <https://doi.org/10.1038/nri2156>
- [18] Serhan, C.N., Brain, S.D., Buckley, C.D., Gilroy, D.W., Haslett, C., O'Neill, L.A., Perretti, M., Rossi, A.G. and Wallace, J. (2007) Resolution of Inflammation: State of the Art, Definitions and Terms. *FASEB Journal*, **21**, 325-332. <https://doi.org/10.1096/fj.06-7227rev>
- [19] Nussbaum, C. and Sperando, M. (2011) Innate Immune Cell Recruitment in the Fetus and Neonate. *Journal of Reproductive Immunology*, **90**, 74-81. <https://doi.org/10.1016/j.jri.2011.01.022>
- [20] Nussbaum, C., Klinke, A., Matti, A., Baldus, S. and Sperando, M. (2013) Myeloperoxidase: A Leukocyte-Derived in the Resolution of Acute Inflammation. *Immunity*, **40**, 315-327.
- [21] Buckley, C.D., Gilroy, D.W., Charles, N. and Serhan, C.N. (2014) Pro-Resolving Lipid Mediators and Mechanisms in the Resolution of Acute Inflammation. *Immunity*, **40**, 315-327. <https://doi.org/10.1016/j.immuni.2014.02.009>
- [22] Mazzag, B., Gouget, C., Hwang, Y. and Barakat, A.I. (2014) Cap. 5. Mechanical Force Transmission via the Cytoskeleton in Vascular Endothelial Cells. In: Rosado, J.A. and Redondo, P.C., Eds., *Endothelial Cytoskeleton*, CRC Press, Boca Raton, 91-115.
- [23] Hahn, C. and Schwartz, M.A. (2009) Mechanotransduction in Vascular Physiology and Atherogenesis. *Nature Reviews Molecular Cell Biology*, **10**, 53-62. <https://doi.org/10.1038/nrm2596>
- [24] Guimarães Di Stasi, M. and Pratschke, A. (2020) Acting Cybernetically in Architecture: Homeostasis and Synergy in the Work of Buckminster Fuller, Fuller, R.B. (1975). *Cybernetics and Human Knowing*, **27**, 65-88.
- [25] Shimizu, Y. and Garci, J.G.N. (2014) Cap. 1. The Endothelial Cytoskeleton. Multifunctional Role of the Endothelial Actomyosin Cytoskeleton. In: Rosado, J.A. and Redondo, P.C., Eds., *Endothelial Cytoskeleton*, CRC Press, Boca Raton, 1-26.
- [26] Dudek, S., Jacobson, J., Chiang, E., *et al.* (2004) Pulmonary Endothelial Cell Barrier Enhancement by Sphingosine 1-Phosphate: Roles for Cortactin and Myosin Light Chain Kinase. *Journal of Biological Chemistry*, **279**, 24692-24700. <https://doi.org/10.1074/jbc.M313969200>
- [27] Wang, L. and Dudek, S.M. (2009) Regulation of Vascular Permeability by Sphingosine 1-Phosphate. *Microvascular Research*, **77**, 39-45. <https://doi.org/10.1016/j.mvr.2008.09.005>
- [28] Lee, T.Y. and Gotlieb, A.I. (2003) Microfilaments and Microtubules Maintain Endothelial. *Microscopy Research and Technique*, **60**, 115-127. <https://doi.org/10.1002/jemt.10250>
- [29] Belvitch, P., Htwe, Y.M., Brown, M.E. and Dudek, S. (2018) Cortical Actin Dynamics in Endothelial Permeability. In: Belvitch, P. and Dudek, S., Eds., *Current Topics in Membranes*, Elsevier, Amsterdam, 141-195. <https://doi.org/10.1016/bs.ctm.2018.09.003>
- [30] Mazzag, B. and Barakat, A.I. (2010) The Effect of Noisy Flow on Endothelial Cell Mechanotransduction: A Computational Study. *Annals of Biomedical Engineering*, **39**, 911-921. <https://doi.org/10.1007/s10439-010-0181-5>
- [31] Davies, P.F., Spaan, J.A. and Krams, R. (2005) Shear Stress Biology of the Endothe-



- lium. *Annals of Biomedical Engineering*, **33**, 1714-1718.  
<https://doi.org/10.1007/s10439-005-8774-0>
- [32] Helmke, B.P., Goldman, R. and Davies, P.F. (2000) Rapid Displacement of Vimentin Intermediate Filaments in Living Endothelial Cells Exposed to Flow. *Circulation Research*, **86**, 745-752. <https://doi.org/10.1161/01.RES.86.7.745>
- [33] Hsu, H.-J., Lee, C.-F., Locke, A., Vanderzyl, S.Q. and Kaunas, R. (2010) Stretch-Induced Stress Fibre Remodelling and the Activations of JNK and ERK Depend on Mechanical Strain Rate, but Not FAK. *PLOS ONE*, **5**, e12470.  
<https://doi.org/10.1371/journal.pone.0012470>
- [34] Hwang, Y., Gouget Cecile, L.M. and Barakat, A.I. (2012) Mechanisms of Cytoskeleton-Mediated Mechanical Signal Transmission in Cells. *Communicative & Integrative Biology*, **5**, 538-542. <https://doi.org/10.4161/cib.21633>
- [35] Na, S., Collin, O., Chowdhury, F., Tay, B., Ouyang, M., Ouyang, M., Wang, Y. and Wang, N. (2008) Rapid Signal Transduction in Living Cells Is a Unique Feature of Mechanotransduction. *Proceedings of the National Academy of Sciences of the United States of America*, **105**, 6626-6631.
- [36] Donati, A., Damiani, E., Domizi, R., Romano, R., Adrario, E., Pelaia, P. and Singer, M. (2013) Alteration of the Sublingual Microvascular Glycocalyx in Critically Ill Patients. *Microvascular Research*, **90**, 86-89.  
<https://doi.org/10.1016/j.mvr.2013.08.007>
- [37] Pries, A.R. (2016) Coronary Microcirculatory Pathophysiology: Can We Afford It to Remain a Black Box? *European Heart Journal*, **38**, 478-488.  
<https://doi.org/10.1093/eurheartj/ehv760>
- [38] Rode, B., Shi, J., Endesh, N., Drinkhill, P., Webster, P.J., Lotteau, S., *et al.* (2017) Piezo1 Channels Sense Whole Body Physical Activity to Reset Cardiovascular Homeostasis and Enhance Performance. *Nature Communications*, **8**, Article No. 350.  
<https://doi.org/10.1038/s41467-017-00429-3>
- [39] Lai, A., Chen, Y.C., Cox, C.D., Jaworowski, A., Peter, K. and Baratchi, S. (2020) Analyzing the Shear-Induced Sensitization of Mechanosensitive Ion Channel Piezo-1 in Human Aortic Endothelial Cells. *Journal of Cellular Physiology*, **236**, 2976-2987.  
<https://doi.org/10.1002/jcp.30056>
- [40] Lewin, G. (2018) Molekulare Physiologie der somatosensorischen Wahrnehmung. Max-Delbrück-Centrum für Molekulare Medizin in der Helmholtz-Gemeinschaft. Gruppenleiter. Pressemitteilung Nr. 5./15. März 2018/Berlin.  
<https://www.mdc-berlin.de/de/news/press/wie-zellen-sich-vor-mechanischer-ueberreizung-schuetzen>
- [41] Exposure to Inanimate Mechanical Forces (Items W20-W49).  
<https://www.icd10data.com/ICD10CM/Codes/V00-Y99/W20-W49>
- [42] External Causes/Exposure to Other Mechanism.  
<https://icd.who.int/browse11/l-m/en#/http://id.who.int/icd/entity/1574666141>
- [43] Evans, A. (2017) Environmental Noise Pollution: Has Public Health Become Too Utilitarian? *Open Journal of Social Sciences*, **5**, 80-107.  
<https://doi.org/10.4236/jss.2017.55007>
- [44] Pilger, C. and Ceranna, L. (2017) The Influence of Periodic Wind Turbine Noise on Infrasound Array Measurements. *Journal of Sound and Vibration*, **388**, 188-200.  
<https://doi.org/10.1016/j.jsv.2016.10.027>
- [45] Roos, W. and Vahl, C.F. (2021) Infraschall aus technischen Anlagen. Wissenschaftliche Grundlagen für eine Bewertung gesundheitlicher Risiken. *ASU Arbeitsmed Sozialmed Umweltmed*, **56**, 420-430. <https://doi.org/10.17147/asu-2107-7953>
- [46] Vanderkooy, J. and Mann, R. (2014) Measuring Wind Turbine Coherent Infrasound.

- [47] Douglas, C. and Giancoli, D.C. (2019) Physik. Vol. 4, Pearson Deutschland GmbH, München.
- [48] Krahé, D., Schreckenberger, D., Ebner, F., Eulitz, C. and Möhler, U. (2014) Machbarkeitsstudie zu Wirkungen von Infraschall. Entwicklung von Untersuchungsdesigns für die Ermittlung der Auswirkungen von Infraschall auf den Menschen durch unterschiedliche Quellen. Verlag Umweltbundesamt.  
<https://www.umweltbundesamt.de/publikationen/machbarkeitsstudie-zu-wirkungen-von-infraschall>
- [49] Weichenberger, M., Bauer, M., Kühler, R., *et al.* (2017) Altered Cortical and Subcortical Connectivity due to Infrasound Administered near the Hearing Threshold—Evidence from fMRI. *PLOS ONE*, **12**, e0174420.  
<https://doi.org/10.1371/journal.pone.0174420>
- [50] Alves-Pereira, M. and Branco, C. (2007) Vibroacoustic Disease: Biological Effects of Infrasound and Low-Frequency Noise Explained by Mechanotransduction Cellular Signalling. *Progress in Biophysics and Molecular Biology*, **93**, 256-279.  
<https://doi.org/10.1016/j.pbiomolbio.2006.07.011>  
<http://www.sciencedirect.com/science/article/pii/S0079610706000927>
- [51] Branco, C. and Alves-Pereira, M. (2015) Low Frequency Noise-Induced Pathology: Contributions Provided by the Portuguese Wind Turbine Case. *Euronoise 2015*, Maastricht, 31 May-3 June 2015, 2659-2661.  
[https://www.researchgate.net/publication/290444707\\_Low\\_Frequency\\_Noise-Induced\\_Pathology\\_Contributions\\_Provided\\_by\\_the\\_Portuguese\\_Wind\\_Turbine\\_Case](https://www.researchgate.net/publication/290444707_Low_Frequency_Noise-Induced_Pathology_Contributions_Provided_by_the_Portuguese_Wind_Turbine_Case)
- [52] Louishina, A., Oliveira, R.M.J., Borrecho, G., Brito, J., Oliveira, P., Oliveira da Carvalho, A., *et al.* (2018) Infrasound Induces Coronary Perivascular Fibrosis in Rats. *Cardiovascular Pathology*, **37**, 39-44.  
<https://doi.org/10.1016/j.carpath.2018.10.004>
- [53] Liu, Z., Gong, L., Li, X., *et al.* (2012) Infrasound Increases Intracellular Calcium Concentration and Induces Apoptosis in Hippocampi of Adult Rats. *Molecular Medicine Reports*, **5**, 73-77. <https://doi.org/10.3892/mmr.2011.597>
- [54] Pei, Z., Chen, B.Y., Tie, R., *et al.* (2011) Infrasound Exposure Induces Apoptosis of Rat Cardiac Myocytes by Regulating the Expression of Apoptosis-Related Proteins. *Cardiovascular Toxicology*, **11**, 341-346. <https://doi.org/10.1007/s12012-011-9126-y>
- [55] Zhang, M.Y., Chen, C., Xie, X.J., *et al.* (2016) Damage to Hippocampus of Rats after Being Exposed to Infrasound. *Biomedical and Environmental Sciences*, **29**, 435-442.
- [56] Zhou, X., Yang, Q., Song, F., *et al.* (2020) Tetrahydroxystilbene Glucoside Ameliorates Infrasound-Induced Central Nervous System (CNS) Injury by Improving Antioxidant and Anti-Inflammatory Capacity. *Oxidative Medicine and Cellular Longevity*, **2020**, Article ID: 6576718. <https://doi.org/10.1155/2020/6576718>
- [57] Chaban, R., Ghazy, A., Georgiadem, E., Stumpf, N. and Vahl, C.F. (2021) Negative Effect of High-Level Infrasound on Human Myocardial Contractility: *In Vitro* Controlled Experiment. *Noise Health*, **23**, 57-66.
- [58] Zhang, H., Qi, P., Si, S.Y. and Ma, W.M. (2013) Effect of Infrasound on the Growth of Colorectal Carcinoma in Mouse. *Chinese Journal of Cancer Prevention and Treatment*, **20**, 1145-1149.
- [59] Dumbille, A., McMurtry, R.Y. and Krogh Marie, C. (2021) Wind Turbines and Adverse Health Effects: Applying Bradford Hill's Criteria for Causation. *Environmental Disease*, **6**, 65-87.
- [60] Bittner-Mackin, E. (2006) Excerpts from the Final Report of the Township of Lincoln Wind Turbine Moratorium Committee. Zoning Board of Appeals, Bureau County. <http://www.aweo.org/windlincoln.html>

- [61] Nissenbaum, M.A., Aramini, J.J. and Hanning, C.D. (2012) Effects of Industrial Wind Turbine Noise on Sleep and Health. *Noise Health*, **14**, 237-243. <https://www.noiseandhealth.org/text.asp?2012/1460/237/102961>  
<https://doi.org/10.4103/1463-1741.102961>
- [62] Walker, B., George, F., Hessler, D.M., Rand, R. and Schomer, P. (2012) A Cooperative Measurement Survey and Analysis of Low Frequency and Infrasound at the Shirley Wind Farm in Brown County, Wisconsin. Report Number 122412-1 (Issued: December 24, 2012). Cooperative Measurement Survey. <https://puc.sd.gov/commission/dockets/electric/2018/EL18-003/testimony/testimony/mogen/Noise%20Exhibit%204.pdf>
- [63] Bräuner, E.V., Jørgensen, J.T., Duun-Henriksen, A.K., Backalarz, C., Laursen, J.E., Pedersen, T.H., Simonsen, M.K. and Andersen, Z.J. (2019) Long-Term Wind Turbine Noise Exposure and the Risk of Incident Atrial Fibrillation in the Danish Nurse Cohort. *Environment International*, **130**, Article ID: 104915. <https://doi.org/10.1016/j.envint.2019.104915>
- [64] Nguyen, D.P., Hansen, K. and Zajamsek, B. (2018) Characterizing Tonal Amplitude Modulation of Wind Farm. *Conference Australian Acoustic Society*, Brisbane, 6 November 2018, 581-590. [https://www.acoustics.asn.au/conference\\_proceedings/AAS2018/abstracts/themes-papers.htm#p101](https://www.acoustics.asn.au/conference_proceedings/AAS2018/abstracts/themes-papers.htm#p101)
- [65] Poulsen, H., Raaschou-Nielsen, O., Hahmann, P.A., Andrea, N., Nordsborg, B.R., Ketzel, M., *et al.* (2019) Long-Term Exposure to Wind Turbine Noise and Risk for Myocardial Infarction and Stroke, a Nationwide Cohort Study. *Environmental Health Perspectives*, **127**, Article No. 37004. <https://doi.org/10.1289/EHP3340>
- [66] De Backer, D., Ospina-Tascon, G., Salgado, D., Favory, R., Creteur, J. and Vincent, J. (2010) Monitoring the Microcirculation in the Critically Ill Patient: Current Methods and Future Approaches. *Intensive Care Medicine*, **36**, 1813-1825. <https://doi.org/10.1007/s00134-010-2005-3>